

NOT181

10.23

# Sanifloor+ 1 Sanifloor+ 2

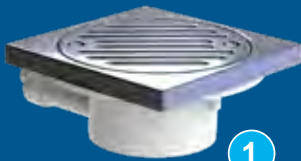

1



2



**FR** NOTICE D'INSTALLATION

**UK** INSTALLATION INSTRUCTIONS

**DE** INSTALLATIONSHINWEISE

**IT** STRUZIONI PER L'INSTALLAZIONE

**ES** MANUAL DE INSTALACIÓN

**PT** MANUAL DE INSTALAÇÃO

**NL** INSTALLATIE VOORSCHRIFTEN

**SE** INSTALLATIONSANVISNING

**DK** INSTALLATIONSVEJLEDNING

**NO** INSTALLASJONSANVISNING

**FI** ASENNUSOHJEET

**HU** FELSZERELÉSI ÉS KEZELÉSI ÚTMUTATÓ

**PL** INSTRUKCJA INSTALACJI

**RU** ИНСТРУКЦИЯ ПО МОНТАЖУ И ЭКСПЛУАТАЦИИ

**RO** MANUAL DE INSTALARE

**CZ** NÁVOD K INSTALACI A POUŽÍVÁNÍ

**TR** KURULUM KILAVUZU

**EL** ΟΔΗΓΙΕΣ ΕΓΚΑΤΑΣΤΑΣΗΣ

**CN** 用户应保留安装指南以备用

**KR** 설치내용서

**HR** UPUTA ZA INSTALACIJU

**AR** بيكرتاللا قيرط



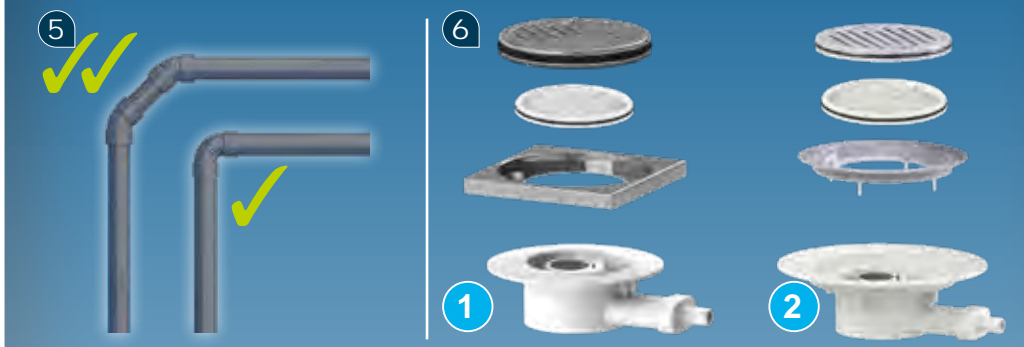
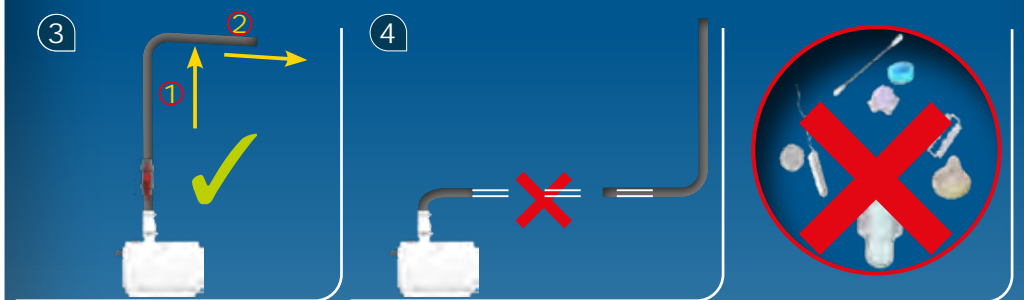
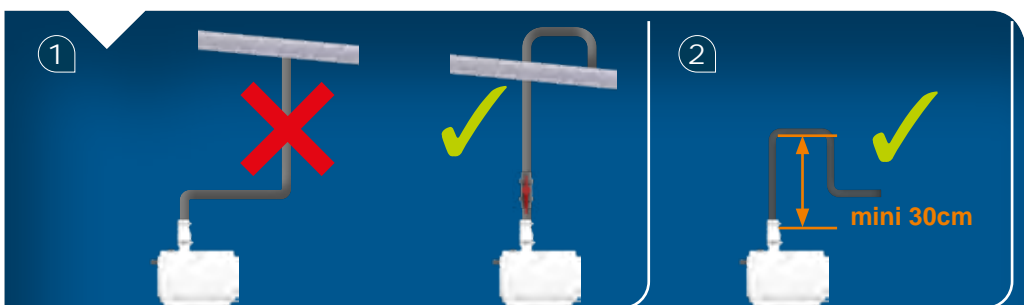
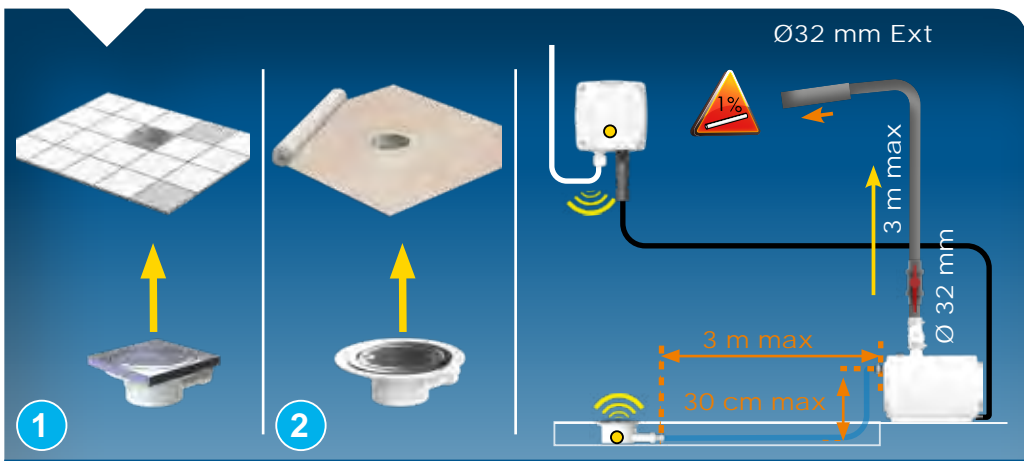

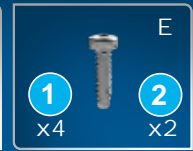
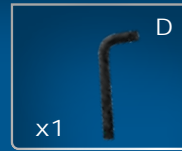
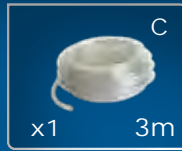
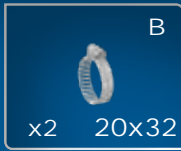
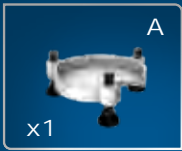

1



2

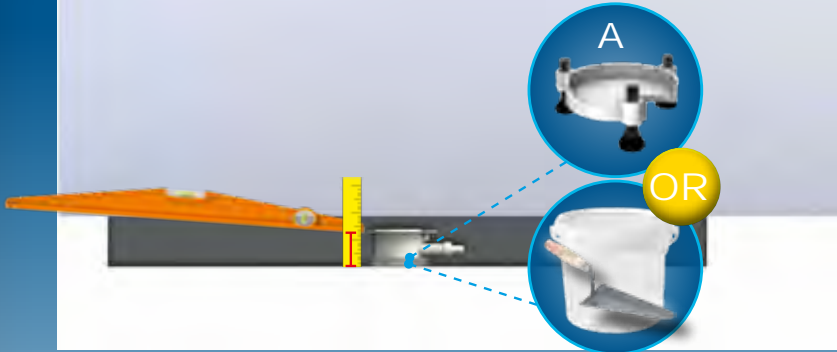

3

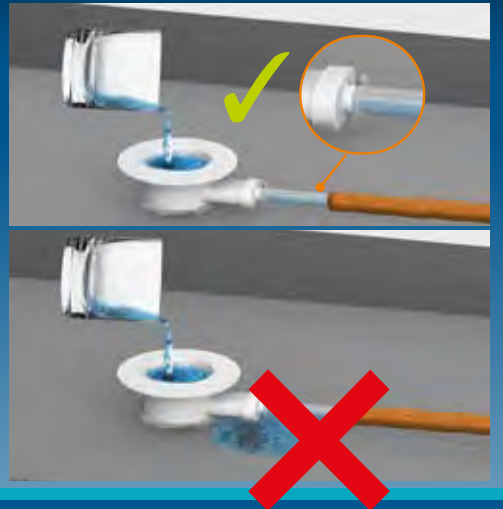
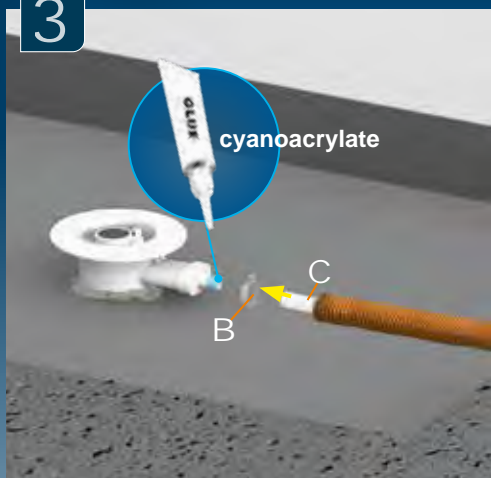

4

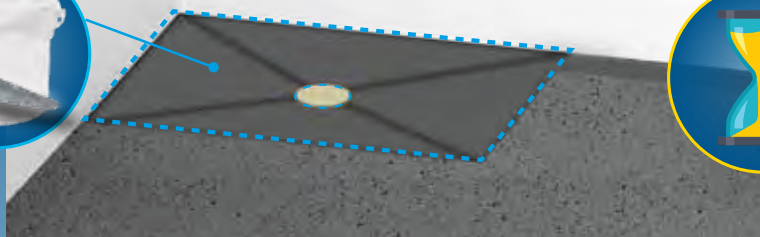

5

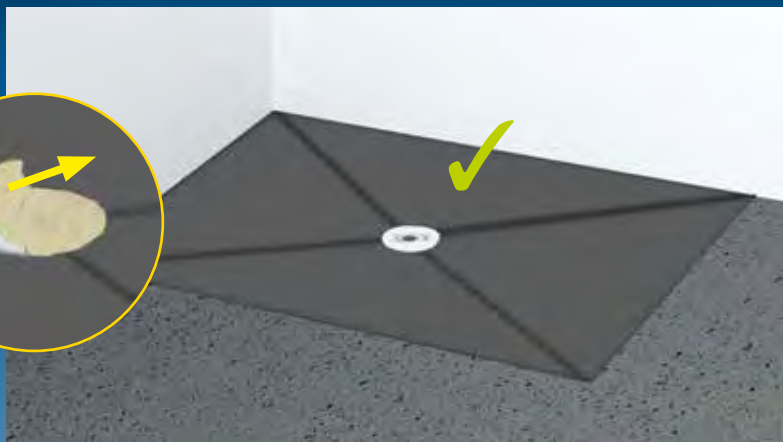

# SANIFLOOR+ 2

6A

A



E



# SANIFLOOR+ 1

6E

A

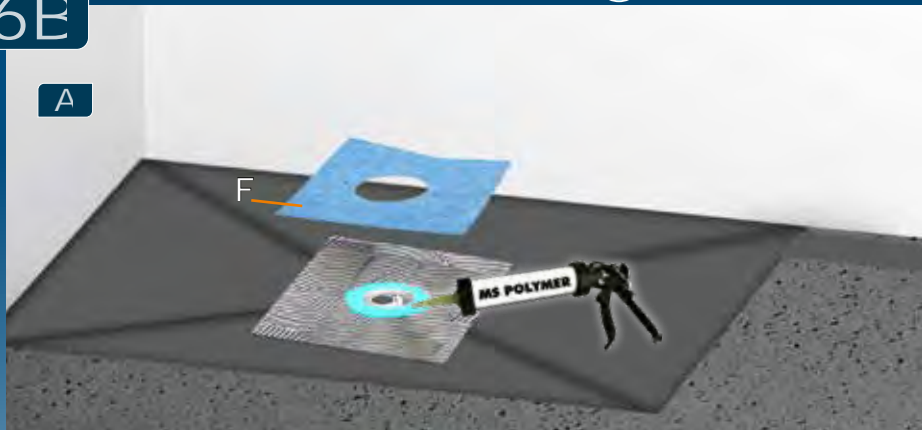

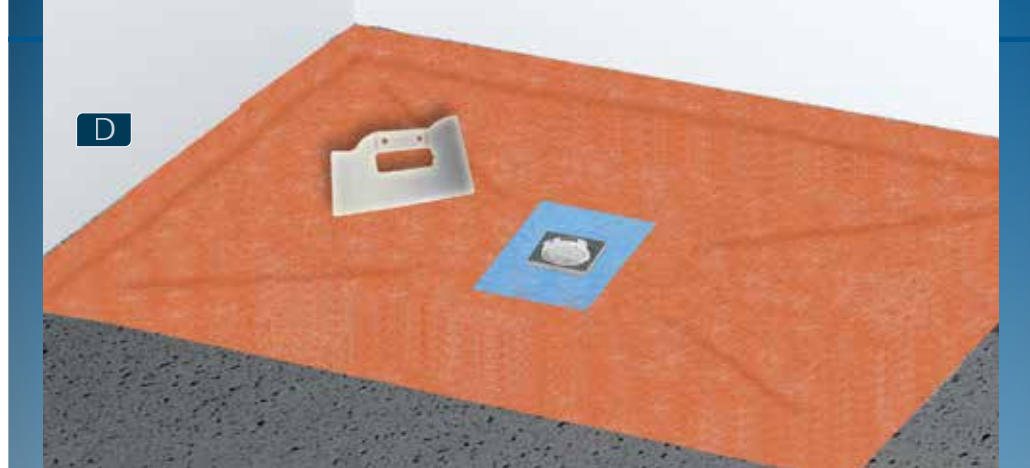
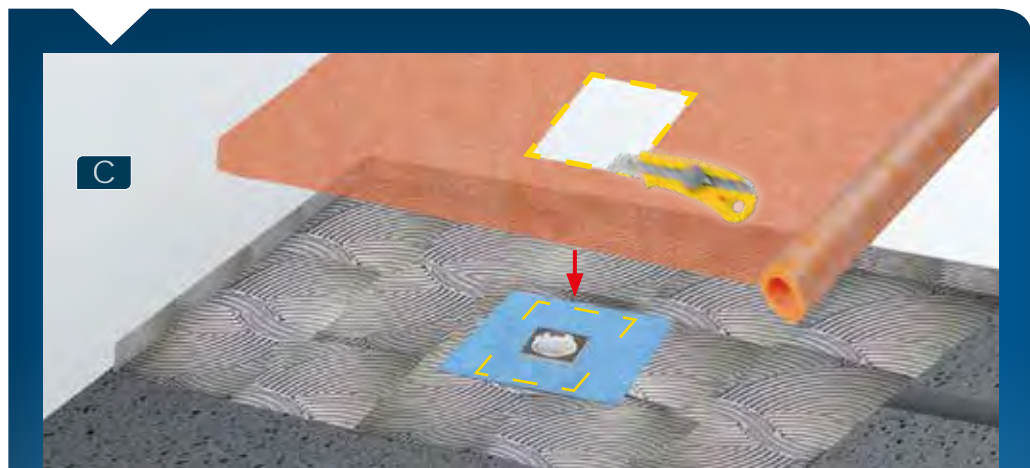
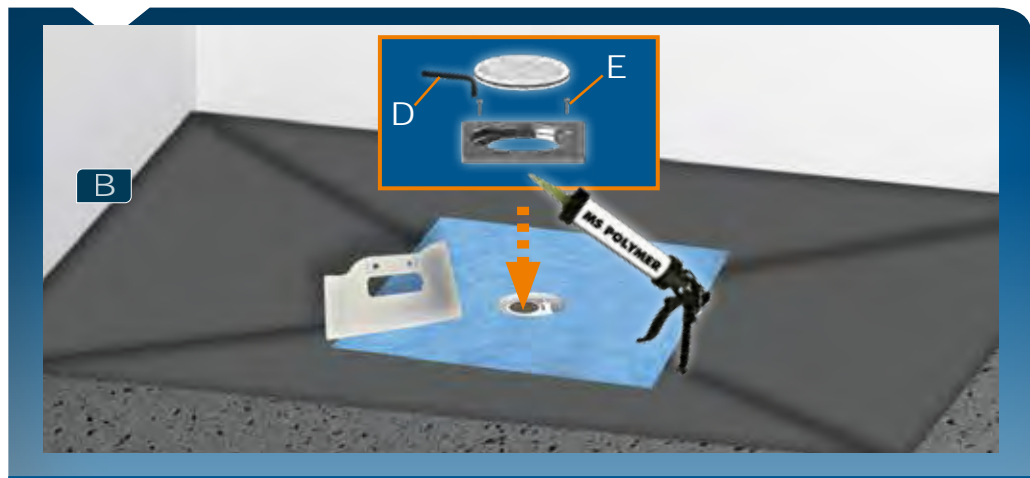

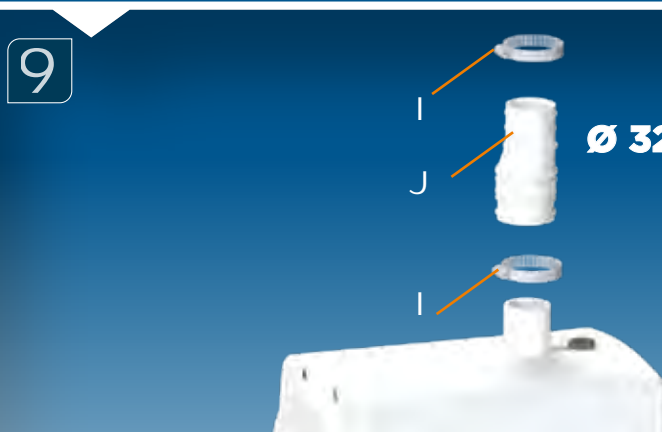
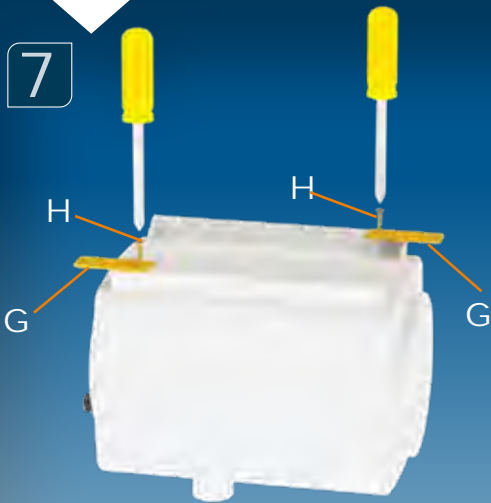
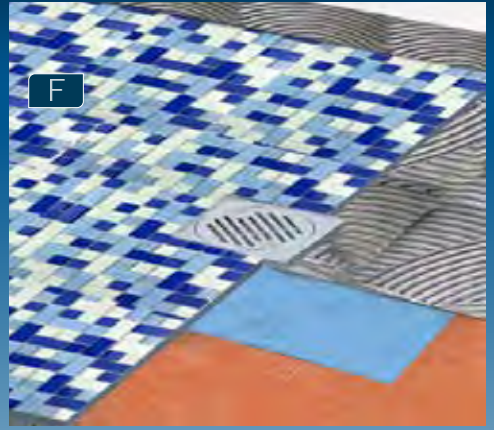
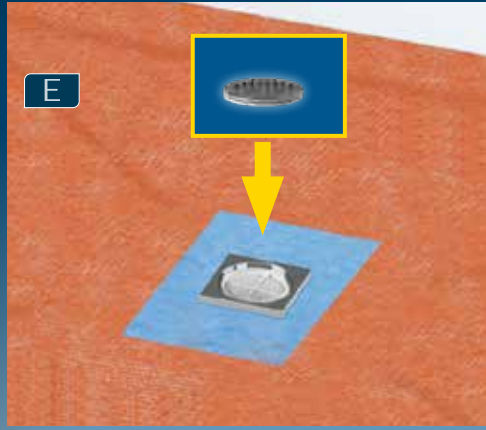

**Ø 32 mm Ext**



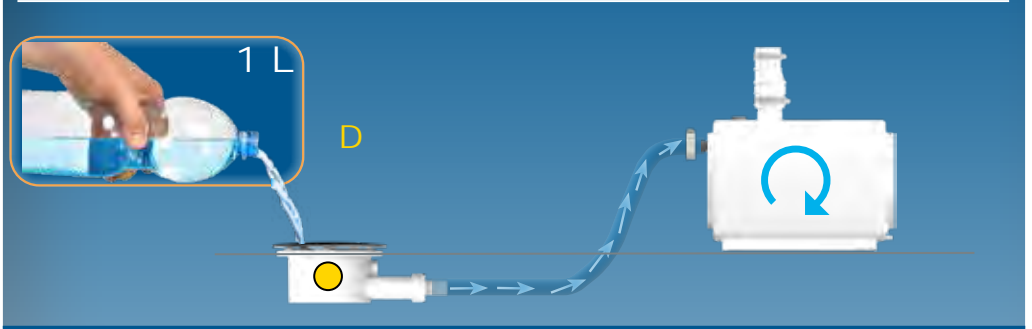
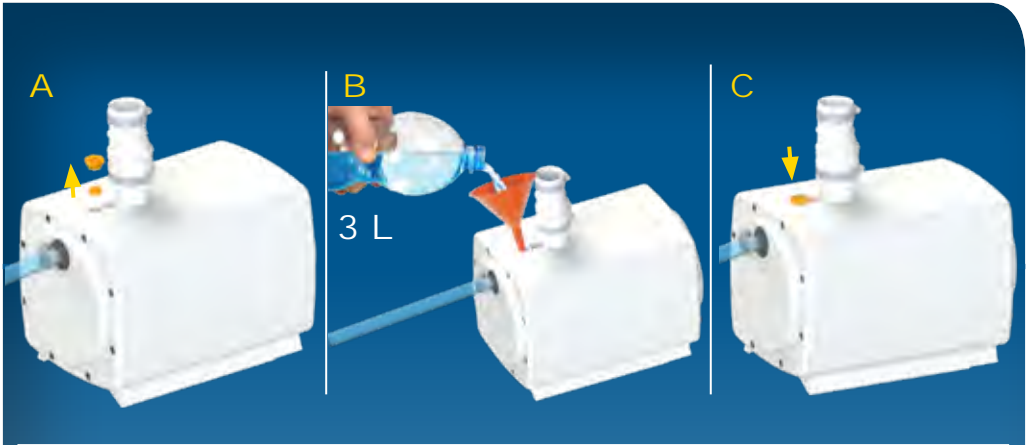

2

a



b

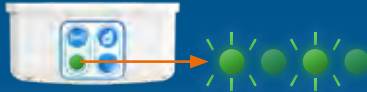

c

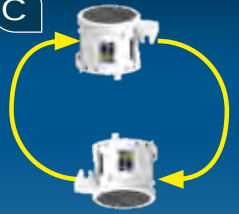

d



e

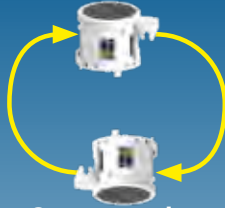

f

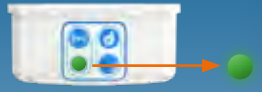

Remplacement module de détection/ Detection module replacement

1

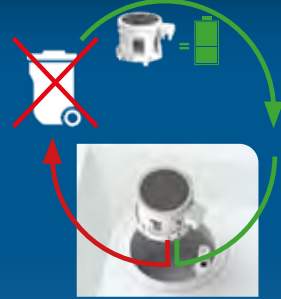
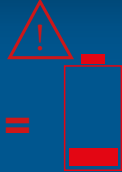

2

a



b



c

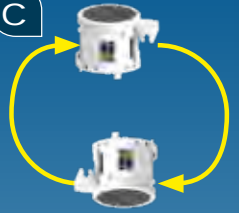

d



e

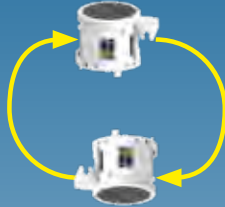

f



# MAINTENANCE

a



b



c



# MAINTENANCE

a



b



c



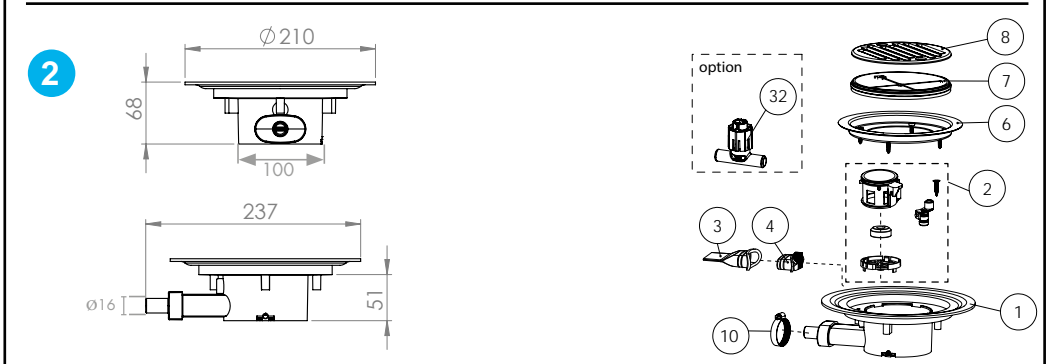
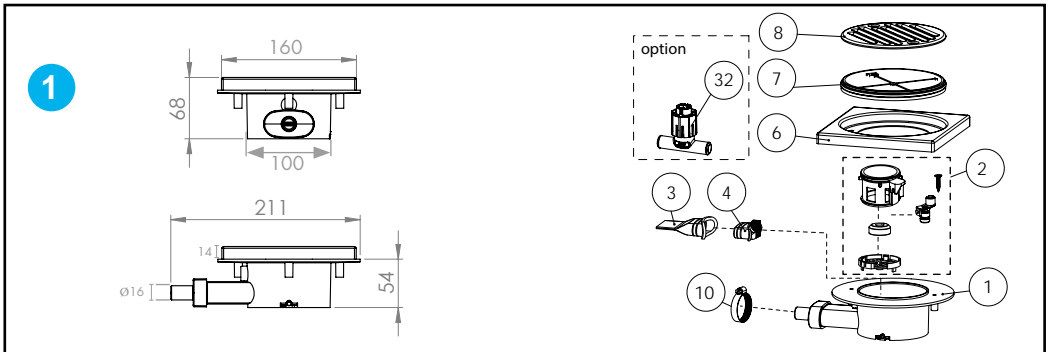
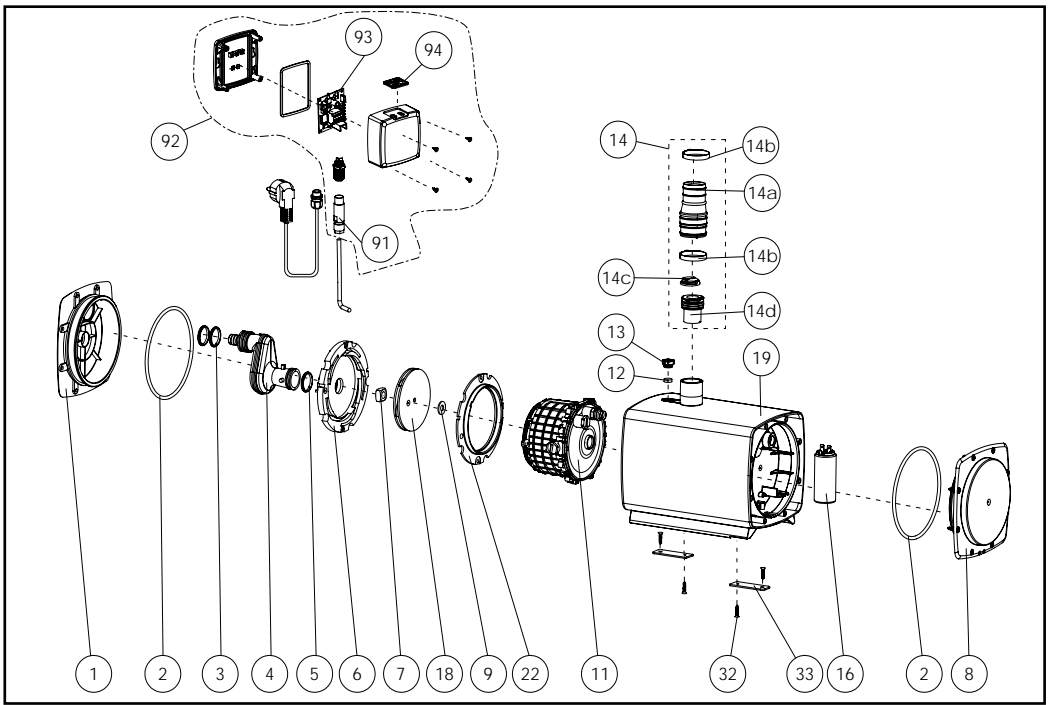

H

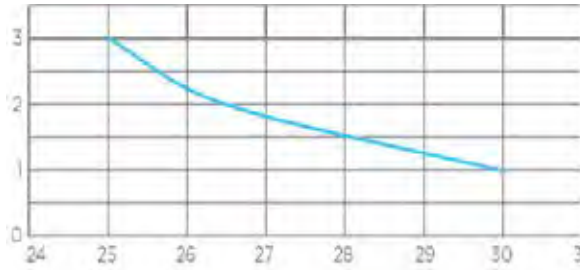

Q (l/min)

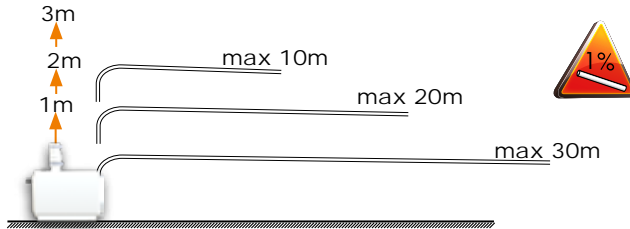

SANIFLOOR+ 1  
 SANIFLOOR+ 2  
 220-240V - 50-60Hz - 400 W - IP44 - 1,7A - - Classe 1

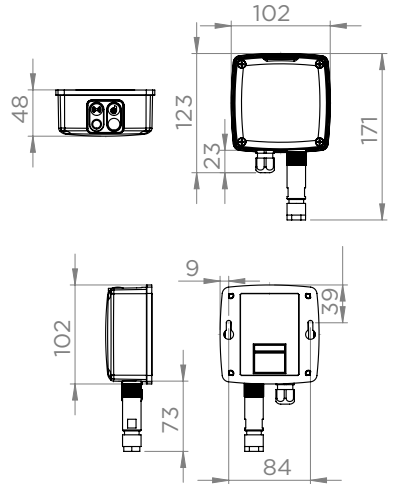
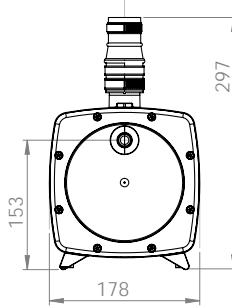
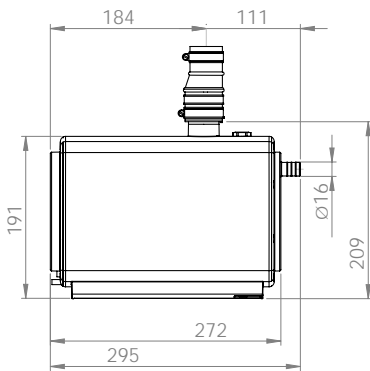

**SERVICE HELPLINES**

France  
 Tel. 01 44 82 25 55  
 Fax. 03 44 94 46 19

United Kingdom  
 Tel. 08457 650011 (Call from a  
 land line)  
 Fax. 020 8842 1671

Ireland  
 Tel. 1850 23 24 25 (LOW CALL)  
 Fax. + 353 46 97 33 093

Australia  
 Tel. +13 00 554 779  
 Fax. +61 2 9882 6950

Deutschland  
 Tel. 0800 82 27 82 0  
 Fax. (060 74) 30928-90

Italia  
 Tel. 0382 6181  
 Fax. +39 0382 618200

España  
 Tel. +34 93 544 60 76  
 Fax. +34 93 462 18 96

Portugal  
 Tel. +351 21 911 27 85  
 Fax. +35 21 957 70 00

Suisse Schweiz Svizzera  
 Tel. +41 (0)32 631 04 74  
 Fax. +41 (0)32 631 04 75

Benelux  
 Tel. +31 475 487100  
 Fax. +31 475 486515

Sverige  
 Tel. +08-404 15 30

Norge  
 Tel. +08-404 15 30

Polska  
 Tel. (+4822) 732 00 33  
 Fax. (+4822) 751 55 16

РОССИЯ  
 Tel. (495) 258 29 51  
 Fax. (495) 258 29 51

Česká Republika  
 Tel. +420 266 712 855  
 Fax. +420 266 712 856

România  
 Tel. +40 724 364 543  
 service@saniflo.ro

Türkiye  
 Tel. +90 212 275 30 88  
 Fax. +90 212 275 90 58

Brazil  
 Tel. (11) 3052-2292

中國  
 Tel. +86(0)21 6218 8969  
 Fax. +86(0)21 6218 8970

South Africa  
 Tel. +27 (0) 21 286 00 28

Service information : [www.sfa.biz](http://www.sfa.biz)

